

# Specialty Viewing Message Center

For Fastener Pack  
(FP-SVMC4-CU-05)

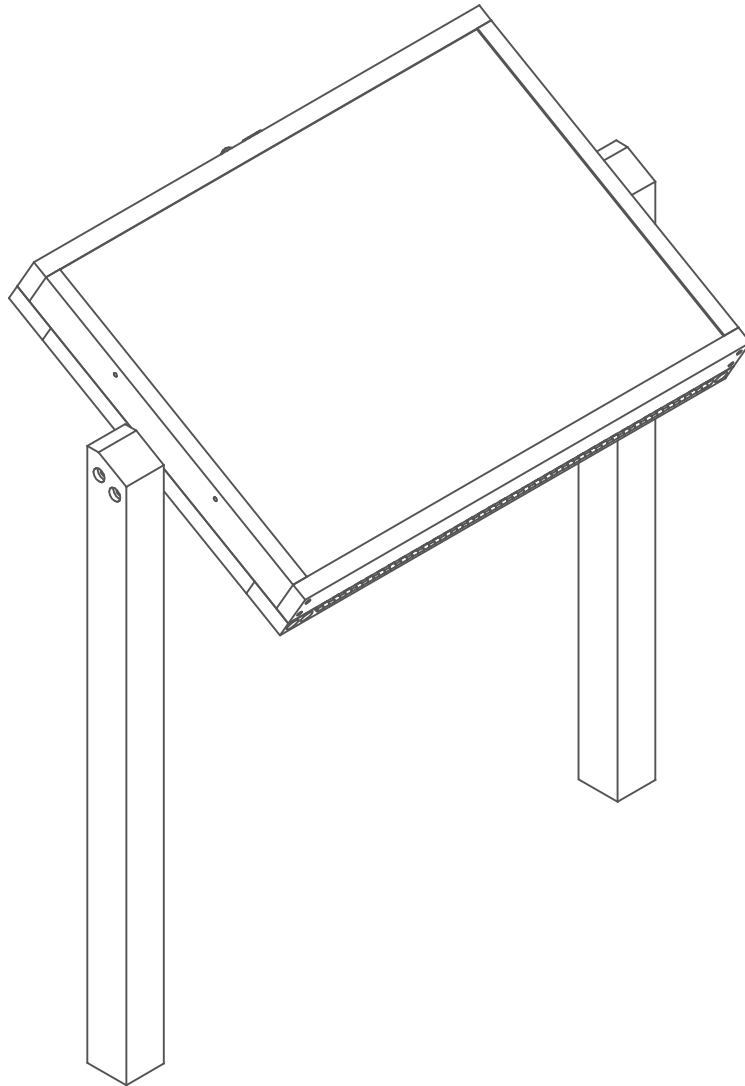

Congratulations !!

You have just purchased the finest recycled plastic  
message center available. Enjoy !!!

Before assembly, please make sure all components are included.

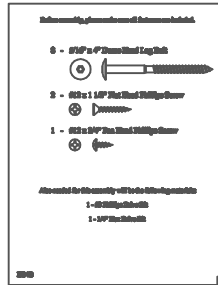

( 1 ) - One Fastener Pack  
FP-SVMC4-CU-05

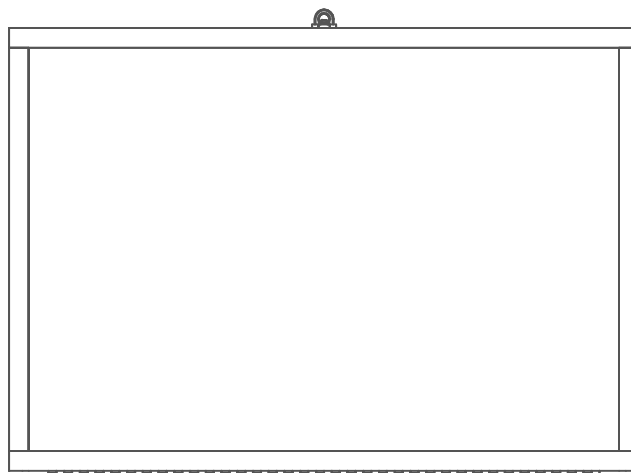

( 1 ) - One - Message Center  
MCSA-SVMC-05



( 1 ) - One Left Side Post  
MP-SVMC-P4-L-01



( 1 ) - One Right Side Post  
MP-SVMC-P4-R-01



( 1 ) - One Under Support  
MP-SVMC-C-01

Before assembly, please make sure all fasteners are included.

4 - 3/8" x 8" Stainless Steel Hex Head Lag Bolt

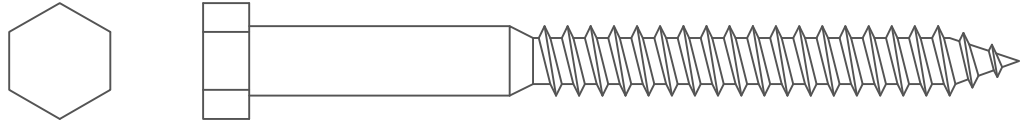

4 - 3/8" Stainless Steel Flat Washer

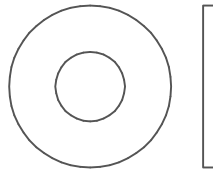

4 - 3/8" Plastic Spacer

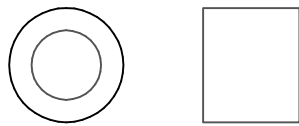

Also needed for this assembly will be the following materials:

1 - 9/16" Socket Wrench

## Step #1

Align the pre drilled holes in the Posts with the pilot holes on the Message Center and Under Support. Fasten them together with (1) - one 3/8" Stainless Steel Flat Washer, (1) - one 3/8"x 8" Stainless Steel Hex Head Lag Bolt, and (1) - one 3/8" Plastic Spacer per aligned hole in the order shown.

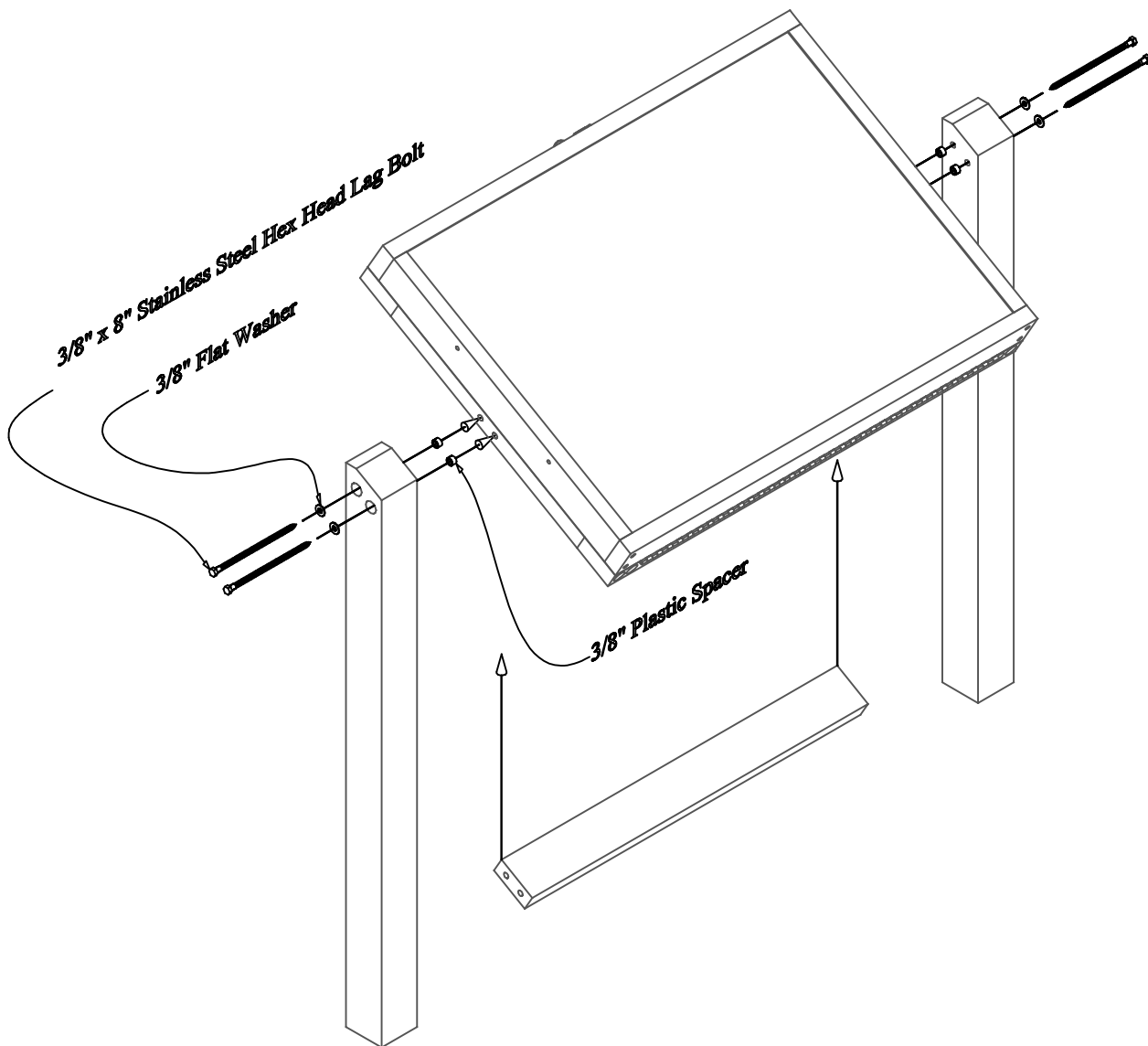

### \*NOTE\*

DO NOT OVER-TIGHTEN THE BOLTS. Tighten to the point where the bolts are snug and the door still opens freely. There may be a small gap between the Message Center body and the Under Support which allows for adjustability.

DEAR VALUED CUSTOMER,

THANK YOU FOR PURCHASING THIS PRODUCT. THIS PRODUCT IS MANUFACTURED USING RECYCLED MATERIALS AND MAY HAVE SLIGHT COLOR VARIATIONS, OCCASIONAL SPECKS OF COLOR OR IRREGULAR SURFACE PATTERNS. THESE ARE NORMAL CONDITIONS OF RECYCLED PLASTICS AND MAKE EACH PIECE OF FURNITURE UNIQUE. THESE CHARACTERISTICS DO NOT AFFECT THE STRENGTH, QUALITY OR PERFORMANCE OF THE PRODUCT.

THANK YOU AGAIN FOR PURCHASING THIS PRODUCT AND HELPING OUR ENVIRONMENT.